

■ INTRODUCTION:

The CE8503 is a constant frequency, current mode step-down converter. The device integrates a main switch and a synchronous rectifier for high efficiency without an external Schottky diode. It is ideal for powering portable equipment that runs from a single cell Lithium-Ion (Li+) battery. The output voltage can be regulated as low as 0.6V. The CE8503 can also run at 100% duty cycle for low dropout operation, extending battery life in portable system. This device offers two operation modes, PWM control and PFM Mode switching control, which allows a high efficiency over the wider range of the load.

The CE8503 is offered in a low profile 5-pin, SOT package, and is available in an adjustable version.

■ FEATURES:

- High efficiency :Up to 96%
- 1.5MHz Constant Frequency Operation
- 800mA Output Current
- No Schottky Diode Required
- 2V to 6.5V Input Voltage Range
- Output Voltage as Low as 0.6V
- PFM Mode for High Efficiency in Light Load
- 100% Duty Cycle in Dropout Operation
- Low Quiescent Current: 20 μ A
- Slope Compensated Current Mode Control for Excellent Line and Load Transient Response
- Short Circuit Protection
- Thermal Fault Protection
- Inrush Current Limit and Soft Start
- <1 μ A Shutdown Current
- SOT23-5 package

■ APPLICATIONS:

- Cellular and Smart Phones
- PDAs
- Wireless and DSL Modems
- Digital Still and Video Cameras
- DTV
- Portable Instruments

■ PIN CONFIGURATION:

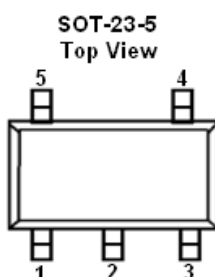

■ ORDER INFORMATION:

CE8503①②

DESIGNATOR	SYMBOL	DESCRIPTION
①	A	Standard
②	M	Package: SOT23-5

Tabel1. Pin Description

PIN NUMBER	PIN NAME	FUNCTION
M		
1	EN	Chip Enable Pin. Drive EN above 1.5V to turn on the part. Drive EN below 0.3V to turn it off. Do not leave EN floating
2	V _{SS}	Analog Ground Pin
3	SW	Power Switch Output. It is the switch node connection to Inductor. This pin connects to the drains of the internal P-ch and N-ch MOSFET switches.
4	V _{IN}	Power Supply Input. Must be closely decoupled to GND with a 4.7μF or greater ceramic capacitor.
5	FB	Output Voltage Feedback Pin. An internal resistive divider divides the output voltage down for comparison to the internal reference voltage.

■ ABSOLUTE MAXIMUM RATINGS(Note1)

PARAMETER	SYMBOL	RATINGS	UNITS
Input Voltage	V _{IN}	V _{SS} -0.3~V _{SS} +7.5	V
CE,SW,FB/V _{OUT} Voltage		V _{SS} -0.3~V _{IN} +0.3	V
Power Dissipation	SOT23-5 P _D	400	mW
Operating Temperature	T _{opr}	-40~+85	°C
Junction Temperature	T _j	150	°C
Storage Temperature	T _{stg}	-40~+125	°C
Soldering Temperature & Time	T _{solder}	260°C, 10s	
ESD HBM(Human Body Mode)	-	2	kV
ESD MM(Machine Mode)	-	200	V

■ ELECTRICAL CHARACTERISTICS

CE8503 Series ($V_{IN}=V_{EN}=3.6V$, $V_{OUT}=1.8V$, $T_A = 25^{\circ}C$, unless otherwise noted.)

PARAMETER	CONDITIONS	MIN	TYP	MAX	UNITS
Input Voltage		2.0		6.5	V
Input DC Supply Current	Note 4)	-	-	-	μA
PWM Mode	$V_{OUT} = 90\%$, $I_{LOAD}=0mA$	-	140	300	μA
PFM Mode	$V_{OUT} = 105\%$, $I_{LOAD} = 0mA$	-	20	35	μA
Shutdown Mode	$V_{EN} = 0V$, $V_{IN}=4.2V$	-	0.1	1.0	μA
Regulated Feedback Voltage VFB	$T_A = 25^{\circ}C$	0.588	0.600	0.612	V
	$T_A = 0^{\circ}C \leq T_A \leq 85^{\circ}C$	0.586	0.600	0.613	V
	$T_A = -40^{\circ}C \leq T_A \leq 85^{\circ}C$	0.585	0.600	0.615	V
Reference Voltage Line Regulation	$V_{IN} = 2.7V$ to $5.5V$	-	0.04	0.40	%/V
Output Voltage Line Regulation	$V_{IN} = 2.7V$ to $5.5V$		0.04	0.40	%
Output Voltage Load Regulation			0.5		%
Oscillation Frequency	$V_{OUT} = 100\%$		1.5		MHz
	$V_{OUT} = 0V$		300		KHz
On Resistance of PMOS	$I_{SW}=100mA$		300	450	m Ω
On Resistance of NMOS	$I_{SW}=-100mA$		300	450	m Ω
Peak Current Limit	$V_{IN} = 3V$, $V_{OUT} = 90\%$		1.5		A
Turn on delay time			0.2		ms
OVP			7.3		V
EN "High" Voltage ⁽¹⁾	V_{ENH}	1.5		V_{IN}	V
EN "Low" Voltage ⁽²⁾	V_{ENL}			0.4	V
EN Leakage Current			± 0.01	± 1.0	μA
SW Leakage Current	$V_{EN}=0V, V_{IN}=V_{SW}=5V$		± 0.01	± 1.0	μA

Note 1: Absolute Maximum Ratings are those values beyond which the life of a device may be impaired.

Note 2: T_J is calculated from the ambient temperature T_A and power dissipation P_D according to the following formula: $T_J = T_A + (P_D) \times (250^{\circ}C/W)$.

Note 3: 100% production test at $+25^{\circ}C$. Specifications over the temperature range are guaranteed by design and characterization.

Note 4: Dynamic supply current is higher due to the gate charge being delivered at the switching frequency.

■ TYPICAL APPLICATION CIRCUITS

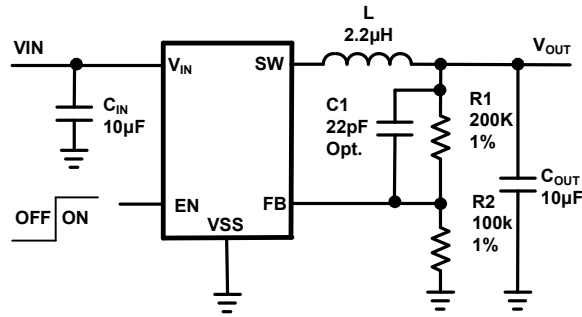
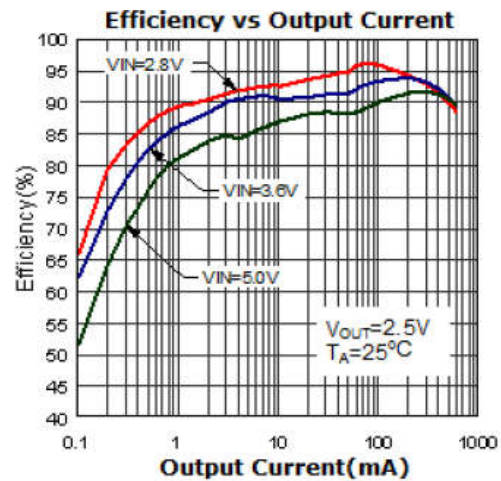
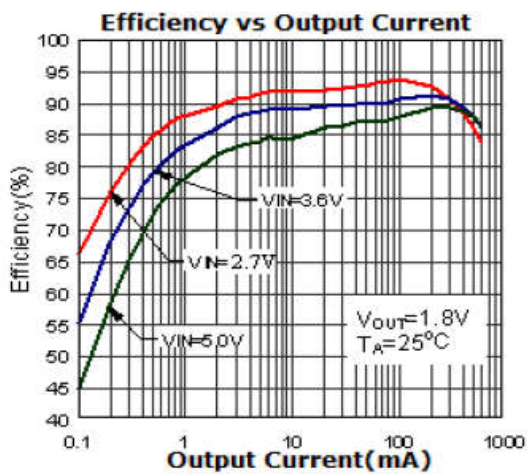
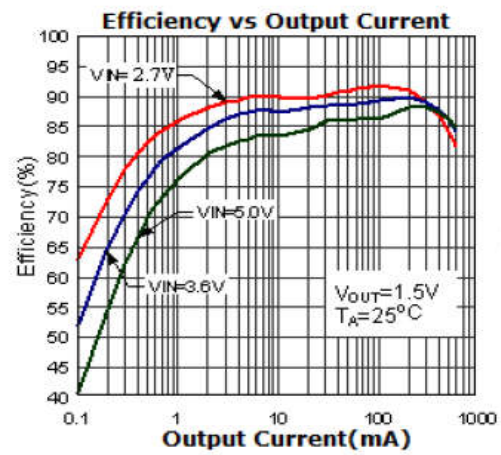
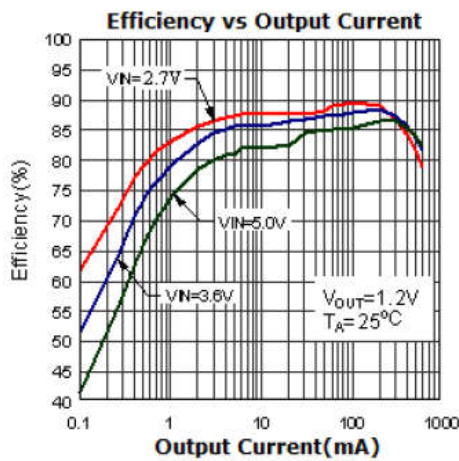
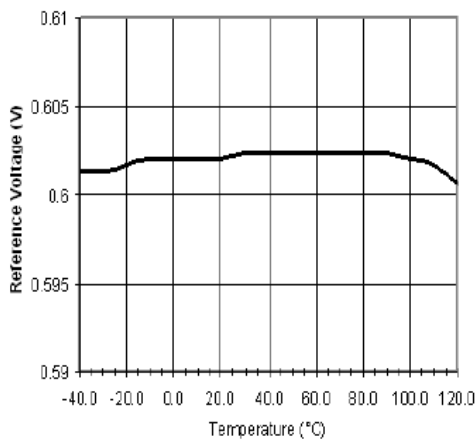
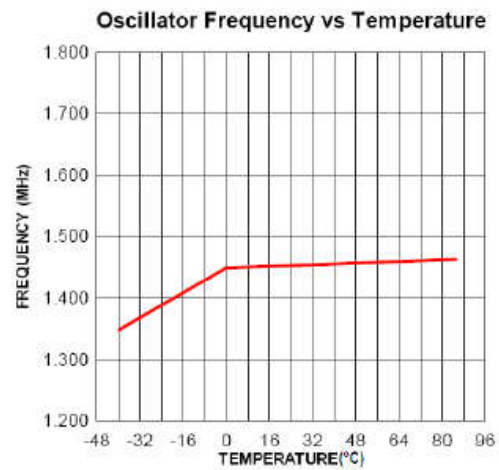
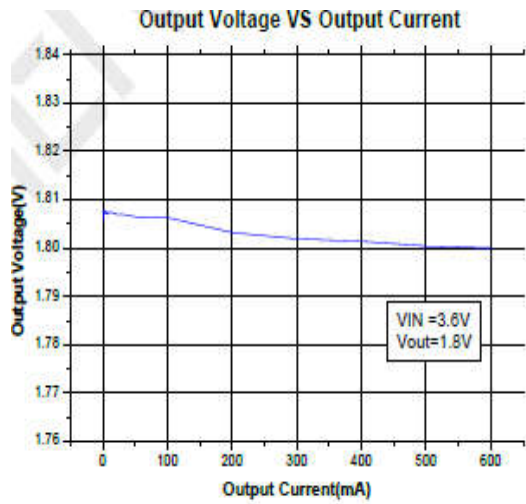

Figure1 Basic Application Circuit

■ TYPICAL PERFORMANCE CHARACTERISTICS
(Test Figure1 above, unless otherwise specified)





PFM MODE

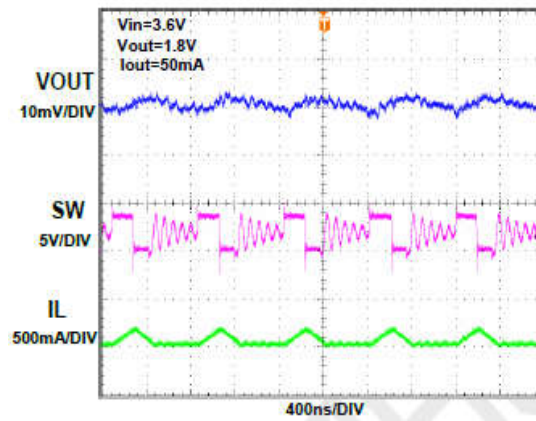

PWM MODE

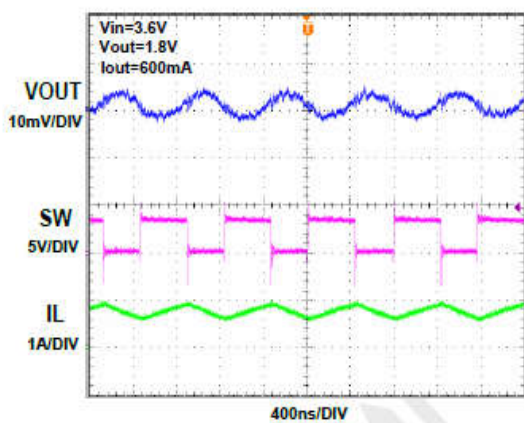

START UP RESPONSE

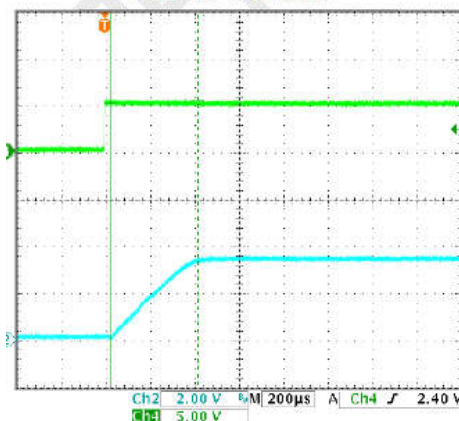

■ FUNCTIONAL BLOCK DIAGRAM

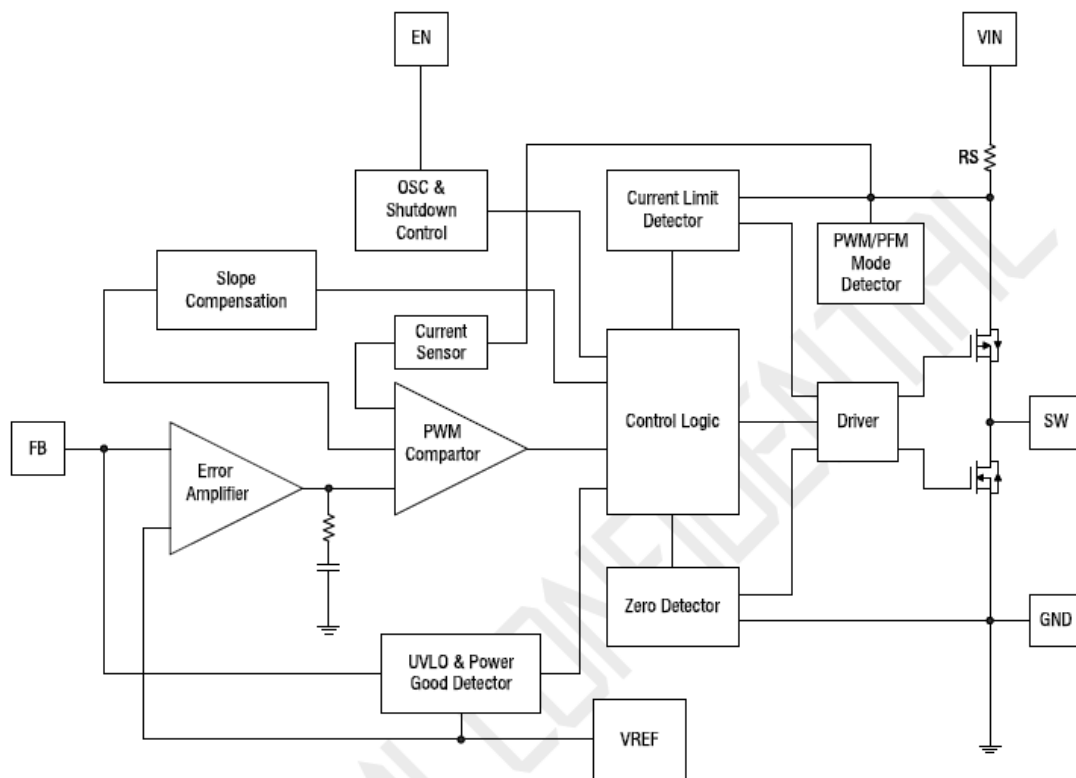
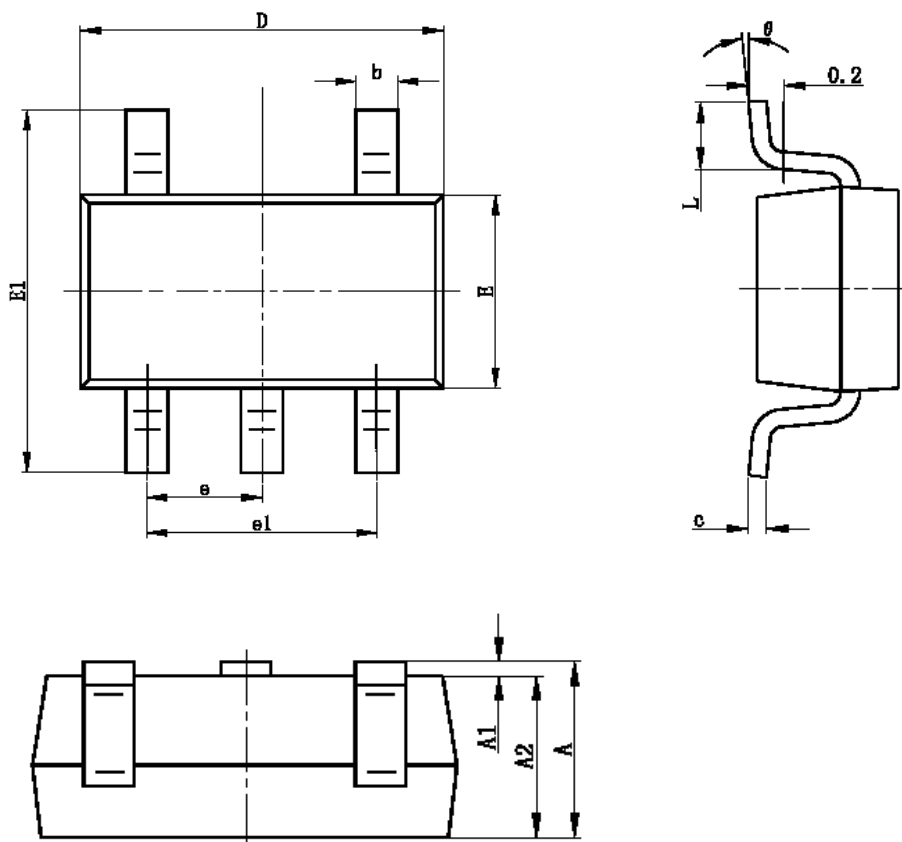

Figure2 Block Diagram

■ PACKAGING INFORMATION

● SOT23-5 Package Outline Dimensions



Symbol	Dimensions In Millimeters		Dimensions In Inches	
	Min	Max	Min	Max
A	1.050	1.250	0.041	0.049
A1	0.000	0.100	0.000	0.004
A2	1.050	1.150	0.041	0.045
b	0.300	0.500	0.012	0.020
c	0.100	0.200	0.004	0.008
D	2.820	3.020	0.111	0.119
E	1.500	1.700	0.059	0.067
E1	2.650	2.950	0.104	0.116
e	0.950(BSC)		0.037(BSC)	
e1	1.800	2.000	0.071	0.079
L	0.300	0.600	0.012	0.024
θ	0°	8°	0°	8°

©Nanjing Chipower Electronics Inc.

Chipower cannot assume responsibility for use of any circuitry other than circuitry entirely embodied in a Chipower product. No circuit patent license, copyrights or other intellectual property rights are implied. Chipower reserves the right to make changes to their products or specifications without notice. Customers are advised to obtain the latest version of relevant information to verify, before placing orders, that information being relied on is current and complete
