

**High PSRR Low Noise**  
**300mA Dual LDO Regulators**

**CE6211 Series**

■ **INTRODUCTION**

The CE6211 Series are a group of dual channel low-dropout voltage regulators designed for portable and wireless applications that require high PSRR, low quiescent current and excellent line and load transient response. The CE6211 includes a reference voltage source, error amplifiers, driver transistors, current limiters and phase compensators internally. The CE6211 is stable with a small 1µF ceramic on the output, which is ideal for battery powered systems for delivering low dropout voltage and low quiescent current. It provides up to 300mA at each channel, from a 2.0V to 6.0V input. The CE6211 is available in 6 pin SOT-23 package.

■ **FEATURES**

- Shutdown Current: < 0.1µA
- Output Current: 300mA
- Output Voltage Range: 1.2V ~ 5.0V, (selectable in 0.1V steps)
- High Accuracy: ±2% (Typ.)
- Dropout Voltage: 100mV@100mA (3.0V Typ.)
- Excellent Line Regulation: 0.01%/V
- Built-in Current Limiter
- Built-in Short Circuit Protection
- Static safety: 2KV@HBM
- TC: 100ppm/°C
- Low ESR Ceramic Capacitor Compatible

■ **APPLICATIONS**

- Mobile phones
- WLAN and Bluetooth appliances
- Portable Audio Equipments
- Cordless telephone
- Cameras, Video recorders
- Battery powered portable devices

■ **BLOCK DIAGRAM**

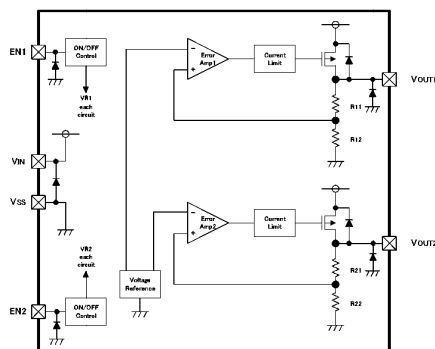

■ **ORDER INFORMATION**

**CE6211** ①②③④⑤

DESIGNATOR	SYMBOL	DESCRIPTION
①②	EE	High Active
③④	I II	I : Regulator1 Output Voltage II : Regulator2 Output Voltage (See Chart1)
⑤	E	Package: SOT-23-6

Chart1 (Regulator1, Regulator2 Output Voltage Indicate)

symbol	Output Voltage	symbol	Output Voltage	symbol	Output Voltage	symbol	Output Voltage
a	0.9	A	3.5	n	2.2	N	4.8
b	1.0	B	3.6	o	2.3	O	4.9
c	1.1	C	3.7	p	2.4	P	5.0
d	1.2	D	3.8	q	2.5	Q	5.1
e	1.3	E	3.9	r	2.6	R	5.2
f	1.4	F	4.0	s	2.7	S	5.3
g	1.5	G	4.1	t	2.8	T	5.4
h	1.6	H	4.2	u	2.9	U	5.5
i	1.7	I	4.3	v	3.0	V	5.6
j	1.8	J	4.4	w	3.1	W	5.7
k	1.9	K	4.5	x	3.2	X	5.8
l	2.0	L	4.6	y	3.3	Y	5.9
m	2.1	M	4.7	z	3.4	Z	6.0

## ■ PIN CONFIGURATION

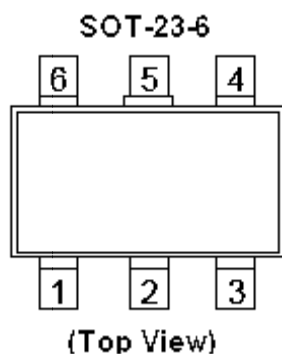

PIN NUMBER	SYMBOL	FUNCTION
1	EN1	ON/OFF Control 1
2	V <sub>IN</sub>	Power Input
3	En2	ON/OFF Control 2
4	V <sub>OUT2</sub>	Output 2
5	V <sub>SS</sub>	Ground
6	V <sub>OUT1</sub>	Output 1

## ■ ABSOLUTE MAXIMUM RATINGS

(Unless otherwise specified, Ta=25°C)

PARAMETER	SYMBOL	RATINGS	UNITS
Input Voltage	V <sub>IN</sub>	V <sub>SS</sub> -0.3~V <sub>SS</sub> +7	V
Output Current	I <sub>OUT1</sub> + I <sub>OUT2</sub>	700	mA
Output Voltage	V <sub>OUT</sub>	V <sub>SS</sub> -0.3~V <sub>IN</sub> +0.3	V
Power Dissipation	SOT-23-6 Pd	250	mW
Operating Temperature	T <sub>opr</sub>	-40~+85	°C
Storage Temperature	T <sub>stg</sub>	-40~+125	°C
Soldering Temperature & Time	T <sub>solder</sub>	260°C, 10s	

**■ ELECTRICAL CHARACTERISTICS**

Regulator1, Regulator2 ( $V_{IN}=V_{OUT}+1V$ ,  $C_{IN}=C_{OUT}=1\mu F$ ,  $T_a=25^\circ C$ , unless otherwise specified)

PARAMETER	SYMBOL	CONDITIONS	MIN	TYP	MAX	UNITS	
Output Voltage	$V_{OUT(E)}$ (Note 2)	$I_{OUT}=40mA$ , $V_{IN}=V_{OUT}+1V$ , $V_{IN}\geq 2V$	$1.5V < V_{OUT} \leq 5.0V$	$V_{OUT} * 0.98$	$V_{OUT}$ (Note 1)	$V_{OUT} * 1.02$	V
			$1.2V \leq V_{OUT} \leq 1.5V$	$V_{OUT} - 0.03$	$V_{OUT}$	$V_{OUT} + 0.03$	V
Supply Current	$I_{SS}$	$V_{EN}=V_{IN}=V_{OUT}+1V$		100	160	$\mu A$	
Shutdown Current	$I_{SHDN}$	$V_{EN} = V_{SS}$		0.1	1.0	$\mu A$	
Output Current	$I_{OUT}$	$V_{IN}\geq 2V$ , $V_{IN}=V_{OUT}+1V$	300			mA	
Dropout Voltage (Note 3)	$V_{dif}$	$I_{OUT} = 100mA$ $V_{OUT}\geq 2.8V$		100		mV	
Load Regulation	$\Delta V_{OUT}$	$V_{IN}= V_{OUT} + 1V$ , $1mA \leq I_{OUT} \leq 100mA$		10		mV	
Line Regulation	$\frac{\Delta V_{OUT}}{\Delta V_{IN} * V_{OUT}}$	$I_{OUT} = 10mA$ $V_{OUT} + 1V \leq V_{IN} \leq 6V$		0.01	0.2	%/V	
Output Voltage Temperature Characteristics	$\frac{\Delta V_{OUT}}{\Delta T * V_{OUT}}$	$I_{OUT} = 10mA$ $-40 \leq T \leq +85$		100		ppm/ $^\circ C$	
Power Supply Ripple Rejection	PSRR	$I_{OUT} = 50mA$ $f = 1KHz$		70		dB	
Short Current	$I_{Short}$	$V_{OUT} = V_{SS}$		100		mA	
Current Limit	$I_{Lim}$	$V_{IN}= V_{OUT} + 1V$		600		mA	
Input Voltage	$V_{IN}$	—	2.0		6.0	V	
CE "High" Voltage	$V_{CE}$ "H"		1.5		$V_{IN}$	V	
CE "Low" Voltage	$V_{CE}$ "L"				0.3	V	

**NOTE:**

1.  $V_{OUT}$ : Specified Output Voltage.
2.  $V_{OUT} (E)$  : Effective Output Voltage ( I.e. The Output Voltage When  $V_{IN} = (V_{OUT} + 1.0V)$  And Maintain A Certain  $I_{OUT}$  Value).
3.  $V_{dif}$ : The Difference Of Output Voltage And Input Voltage When Input Voltage Is Decreased Gradually Till Output Voltage Equals To 98% Of  $V_{OUT} (E)$ ; When  $V_{OUT} < 2.0V$ ,  $V_{IN} \geq 2.0V$  Should be Guaranteed.

**■ TYPICAL APPLICATION**

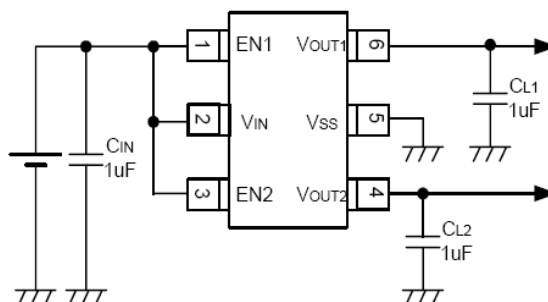

■ **TYPICAL PERFORMANCE CHARACTERISTICS**

(1) **Output Voltage vs. Input Voltage**

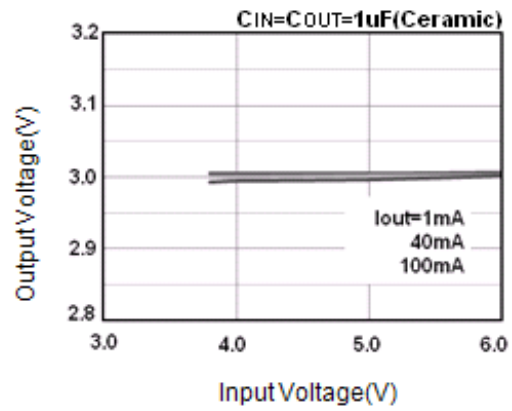
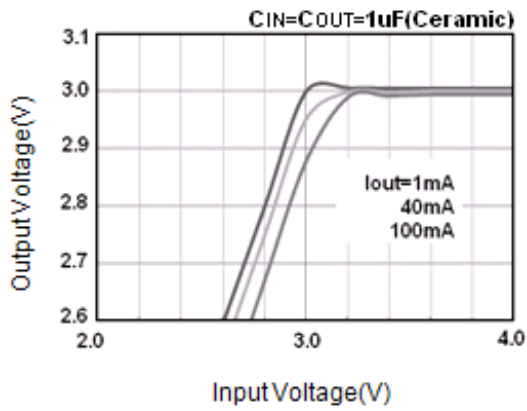

(2) **Input Transient Response 1**

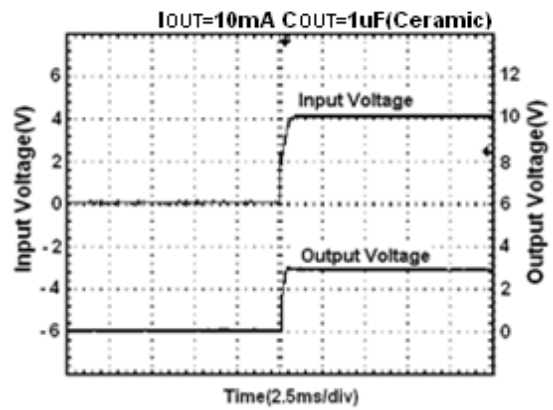
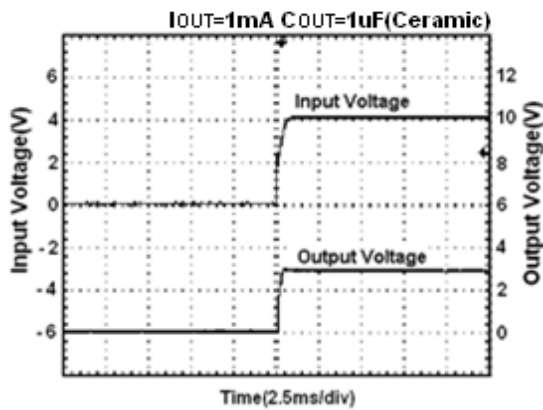

(3) **Input Transient Response 2**

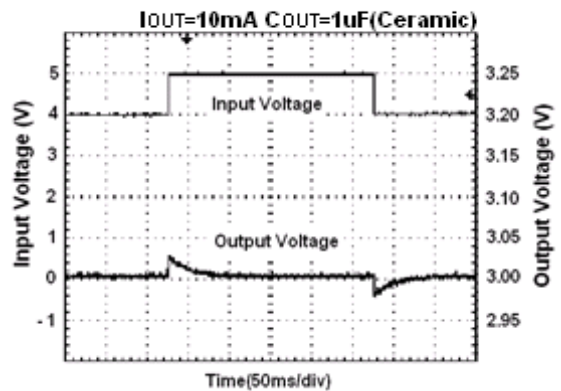
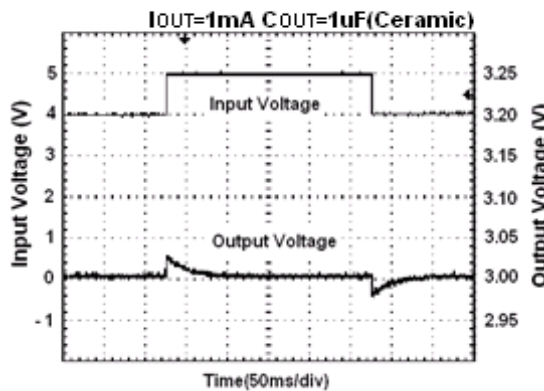

(4) EN Shutdown Response

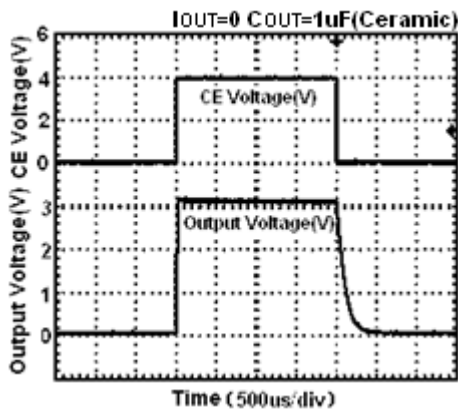

(5) Output Voltage vs. Temperature

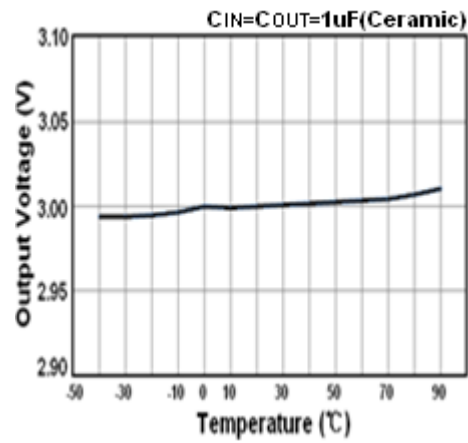

(6) PSRR

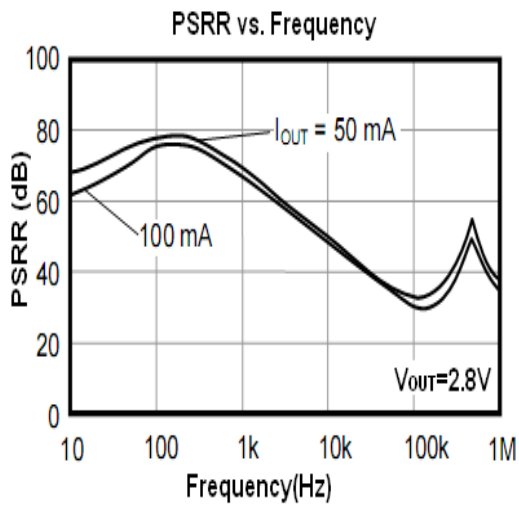

(7) Dropout

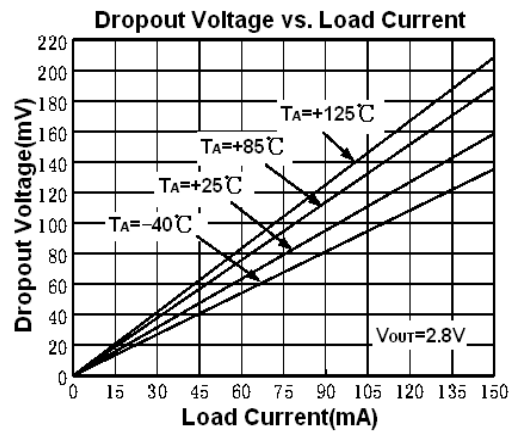

■ PACKAGING INFORMATION

● SOT-23-6 PACKAGE OUTLINE DIMENSIONS

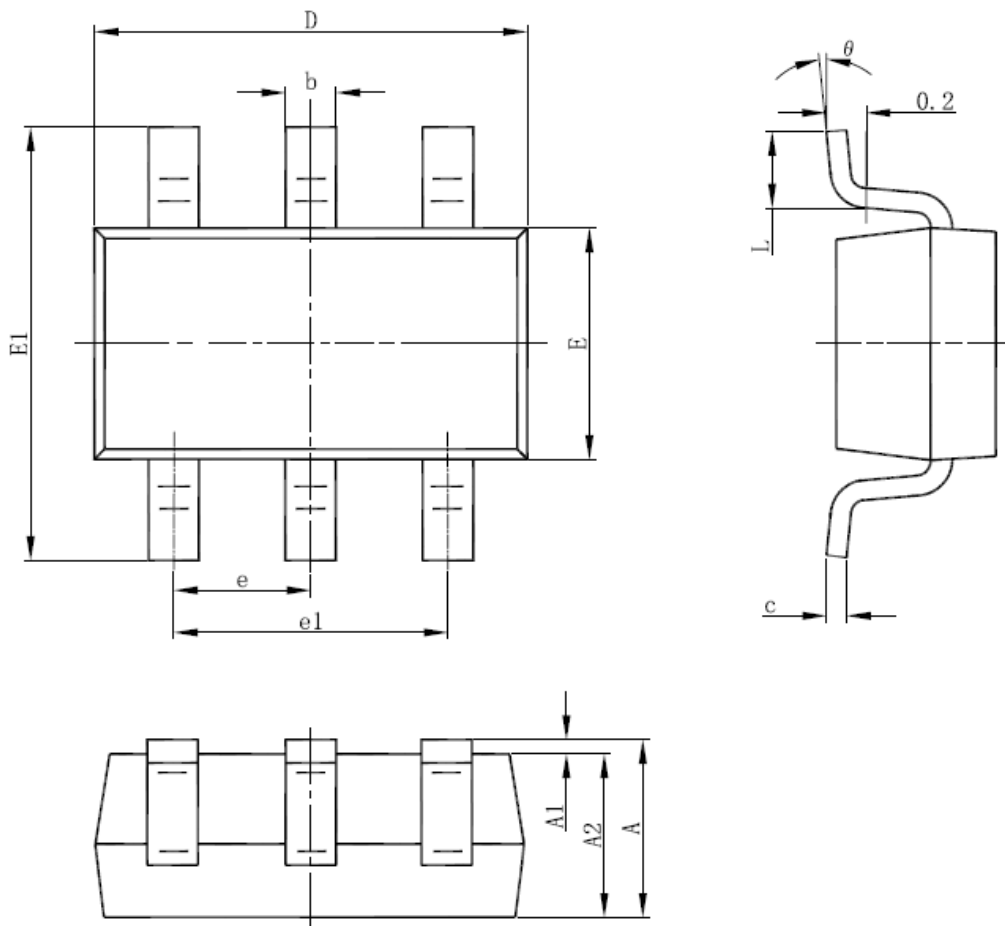

Symbol	Dimensions In Millimeters		Dimensions In Inches	
	Min	Max	Min	Max
A	1.050	1.250	0.041	0.049
A1	0.000	0.100	0.000	0.004
A2	1.050	1.150	0.041	0.045
b	0.300	0.500	0.012	0.020
c	0.100	0.200	0.004	0.008
D	2.820	3.020	0.111	0.119
E	1.500	1.700	0.059	0.067
E1	2.650	2.950	0.104	0.116
e	0.950(BSC)		0.037(BSC)	
e1	1.800	2.000	0.071	0.079
L	0.300	0.600	0.012	0.024
θ	0°	8°	0°	8°

© Nanjing Chipower Electronics Inc.

Chipower cannot assume responsibility for use of any circuitry other than circuitry entirely embodied in a Chipower product. No circuit patent license, copyrights or other intellectual property rights are implied. Chipower reserves the right to make changes to their products or specifications without notice. Customers are advised to obtain the latest version of relevant information to verify, before placing orders, that information being relied on is current and complete.