

Low Dropout Voltage

CE6218 Series

300mA CMOS LDO Reaulator

■ **INTRODUCTION**

The CE6218 Series are a group of positive voltage regulators manufactured by CMOS technologies with high ripple rejection, extremely low power consumption and low dropout voltage, which consume less than 0.1µA in shutdown mode and can provide large output currents even when the difference of the input-output voltage is small. Thus the series are very suitable for the battery-powered equipments, such as Portable/Palm computers, Portable consumer equipments, industry equipments and so on, which want to prolong the using life of the battery.

■ **FEATURES**

- Shutdown Current: < 0.1µA
- Output Current: 300mA
- Output Voltage Range: 0.9V ~ 5.0V, (selectable in 0.1V steps)
- High Accuracy: ±2% (Typ.)
- Dropout Voltage: 150mV@100mA (3.0V Typ.)
- Excellent Line Regulation: 0.1%/V
- Built-in Current Limiter
- Built-in Short Circuit Protection
- Static safety: 2KV@HBM
- TC: 100ppm/°C
- Low ESR Ceramic Capacitor Compatible

■ **APPLICATIONS**

- Battery powered systems
- Portable instrumentations
- Reference Voltage Sources
- Portable consumer equipments
- Portable/Palm computers
- Radio control systems

■ **BLOCK DIAGRAM**

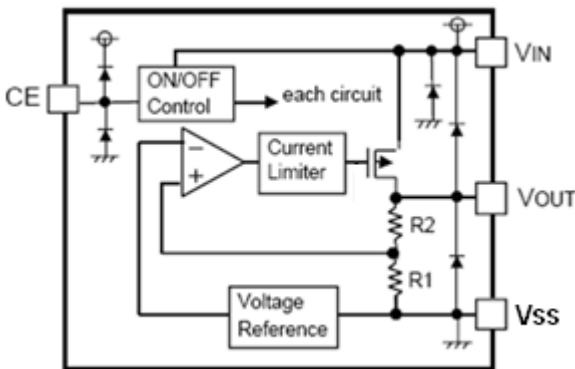

■ **ORDER INFORMATION**

CE6218①②③④

DESIGNATOR	SYMBOL	DESCRIPTION
①	E	With Shutdown Function
②③	Integer	Output Voltage (0.9~5V) e. g: 3.0V=②:3,③:0
④	M	Package: SOT-23-5
	P	Package: SOT-89-5

■ PIN CONFIGURATION (Pin output sequence can be ordered by customer)

SOT-23-5

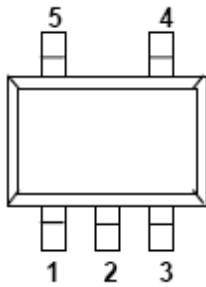

PIN NUMBER	SYMBOL	FUNCTION
1	V_{IN}	Power Input Pin
2	V_{SS}	Ground
3	CE	Chip Enable Pin
4	NC	No Connection
5	V_{OUT}	Output Pin

SOT-89-5

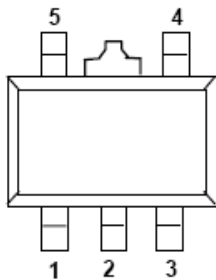

PIN NUMBER	SYMBOL	FUNCTION
1	V_{OUT}	Output Pin
2	V_{SS}	Ground
3	NC	No Connection
4	CE	Chip Enable Pin
5	V_{IN}	Power Input Pin

■ ABSOLUTE MAXIMUM RATINGS

PARAMETER	SYMBOL	RATINGS	UNITS
Input Voltage	V_{IN}	$V_{SS} - 0.3 \sim V_{SS} + 8$	V
Output Current	I_{OUT}	600	mA
Output Voltage	V_{OUT}	$V_{SS} - 0.3 \sim V_{IN} + 0.3$	V
Power Dissipation	SOT-23	P_d	250
	SOT-89	P_d	500
Operating Temperature	T_{opr}	-40~+85	°C
Storage Temperature	T_{stg}	-40~+125	°C
Soldering Temperature & Time	T_{solder}	260°C, 10s	

■ ELECTRICAL CHARACTERISTICS

CE6218 Series

($C_{IN} = C_{OUT} = 1\mu F$, $T_a=25^\circ C$)

PARAMETER	SYMBOL	CONDITIONS	MIN	TYP	MAX	UNITS	
Output Voltage	$V_{OUT(E)}$ (Note 2)	$I_{OUT}=40mA$ $V_{IN}=V_{OUT}+1V$	$1.5V < V_{OUT} \leq 5.0V$	$V_{OUT} * 0.98$	V_{OUT}	$V_{OUT} * 1.02$	V
			$0.9V \leq V_{OUT} \leq 1.5V$	$V_{OUT} - 0.03$	V_{OUT}	$V_{OUT} + 0.03$	V
Supply Current	I_{SS}	$V_{CE}=V_{IN}=V_{OUT}+1V$		5	10	μA	
Shutdown Current	I_{SHDN}	$V_{CE} = V_{SS}$			0.1	μA	
Output Current	I_{OUT}	—	300			mA	
Dropout Voltage (Note 3)	V_{dif1}	$I_{OUT} = 40mA$		60		mV	
	V_{dif2}	$I_{OUT} = 100mA$		150		mV	
Load Regulation	ΔV_{OUT}	$V_{IN}=V_{OUT}+1V,$ $1mA \leq I_{OUT} \leq 100mA$		10		mV	
Line Regulation	$\frac{\Delta V_{OUT}}{\Delta V_{IN} * V_{OUT}}$	$I_{OUT} = 40mA$ $V_{OUT} + 1V \leq V_{IN} \leq 6V$		0.1	0.3	%/V	
Output Voltage Temperature Characteristics	$\frac{\Delta V_{OUT}}{\Delta T * V_{OUT}}$	$I_{OUT} = 40mA$ $-40 \leq T \leq +85$		100		ppm/ $^\circ C$	
Power Supply Ripple Rejection	PSRR	$I_{OUT} = 10mA$ $f = 1kHz$		60		dB	
Short Current	I_{Short}	$V_{OUT} = V_{SS}$		30		mA	
Current Limit	I_{Lim}	$V_{IN}=V_{OUT}+1V$		600		mA	
Input Voltage	V_{IN}	—	2.0		6.0	V	
CE "High" Voltage	V_{CE} "H"		1.0		V_{IN}	V	
CE "Low" Voltage	V_{CE} "L"				0.3	V	

NOTE:

1. V_{OUT} : Specified Output Voltage.
2. $V_{OUT} (E)$: Effective Output Voltage (I.e. The Output Voltage When $V_{IN} = (V_{OUT} + 1.0V)$ And Maintain A Certain I_{OUT} Value).
3. V_{dif} : The Difference Of Output Voltage And Input Voltage When Input Voltage Is Decreased Gradually Till Output Voltage Equals To 98% Of $V_{OUT} (E)$.

■ TYPICAL APPLICATION

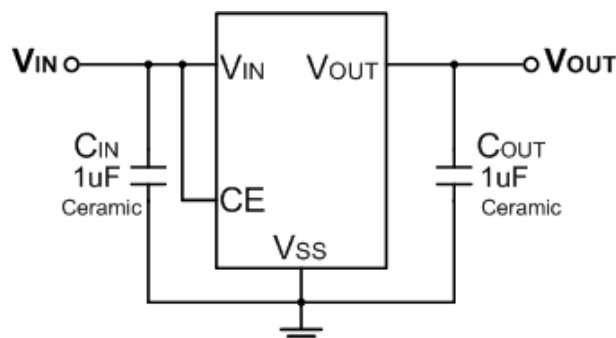

■ TYPICAL PERFORMANCE CHARACTERISTICS (CE6218E30M, for instance)

(1) Output Voltage vs. Input Voltage

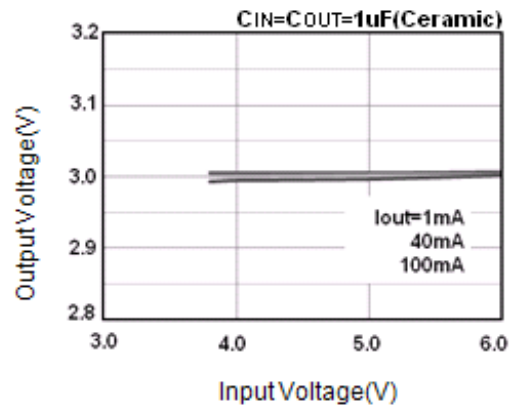
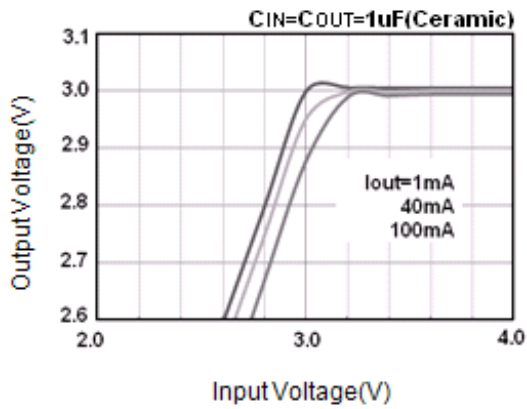

(2) Input Transient Response 1

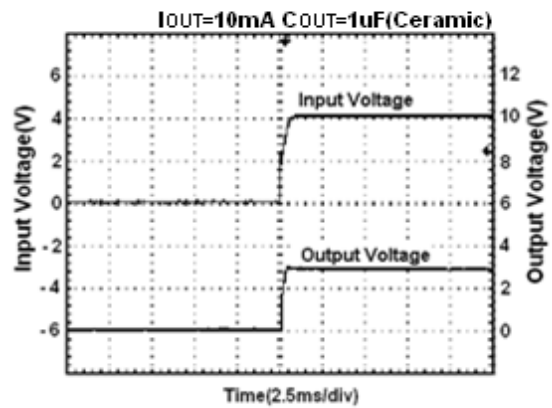
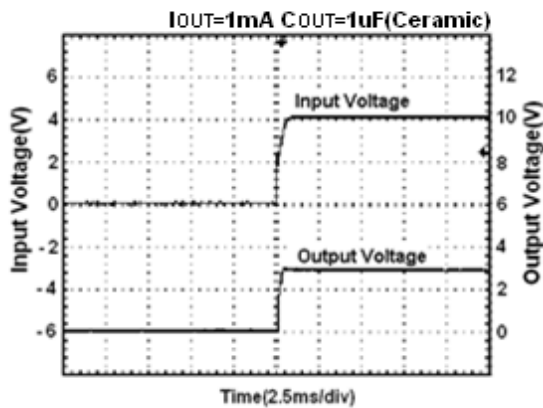

(3) Input Transient Response 2

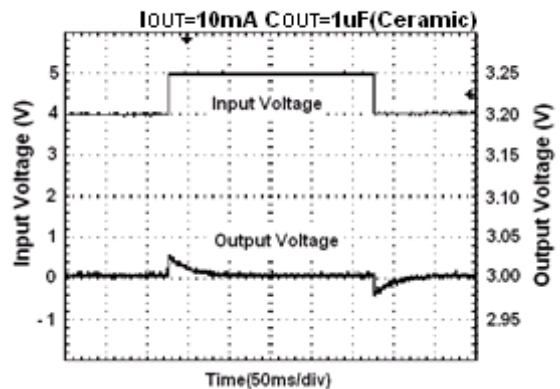
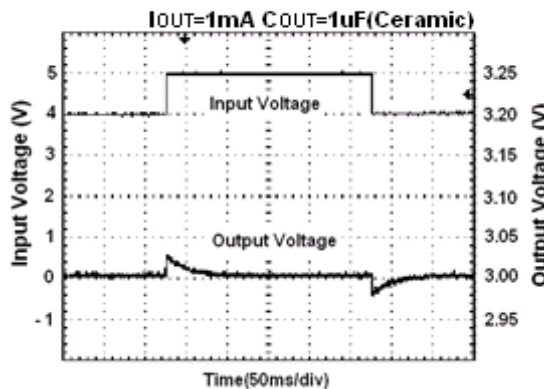

(4) CE Shutdown Response

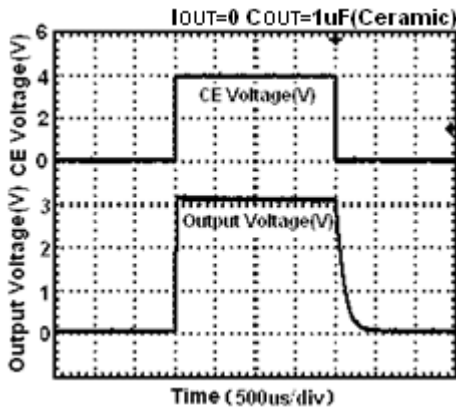

(5) Output Voltage vs. Temperature

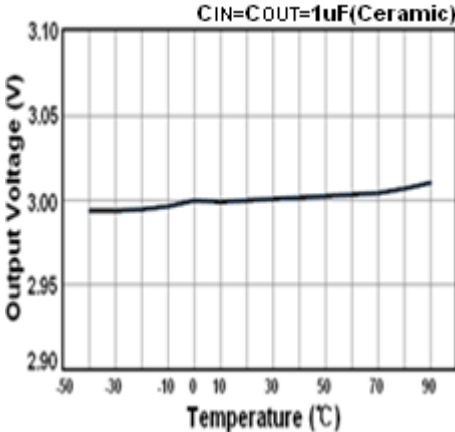

■ PACKAGING INFORMATION

● SOT-23-5 PACKAGE OUTLINE DIMENSIONS

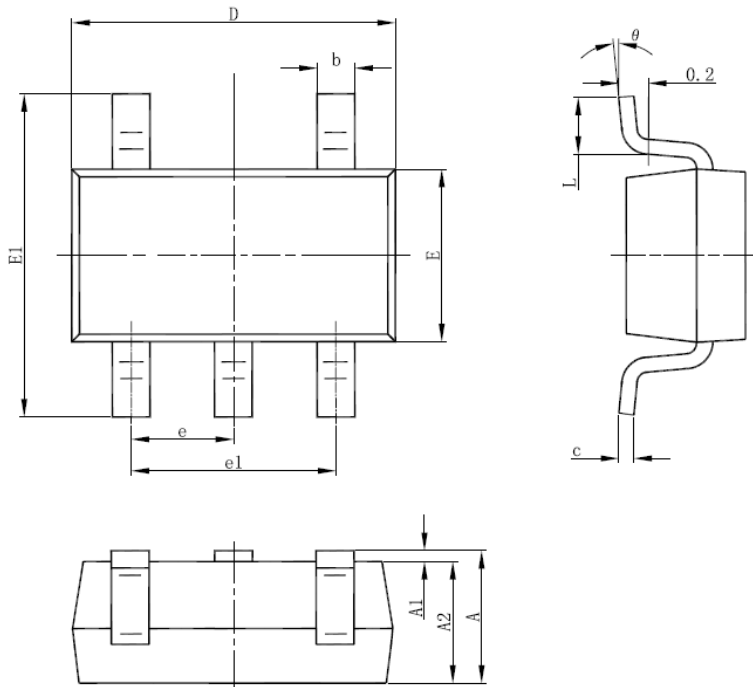

Symbol	Dimensions In Millimeters		Dimensions In Inches	
	Min	Max	Min	Max
A	1.050	1.250	0.041	0.049
A1	0.000	0.100	0.000	0.004
A2	1.050	1.150	0.041	0.045
b	0.300	0.500	0.012	0.020
c	0.100	0.200	0.004	0.008
D	2.820	3.020	0.111	0.119
E	1.500	1.700	0.059	0.067
E1	2.650	2.950	0.104	0.116
e	0.950(BSC)		0.037(BSC)	
e1	1.800	2.000	0.071	0.079
L	0.300	0.600	0.012	0.024
θ	0°	8°	0°	8°

• SOT-89-5 PACKAGE OUTLINE DIMENSIONS

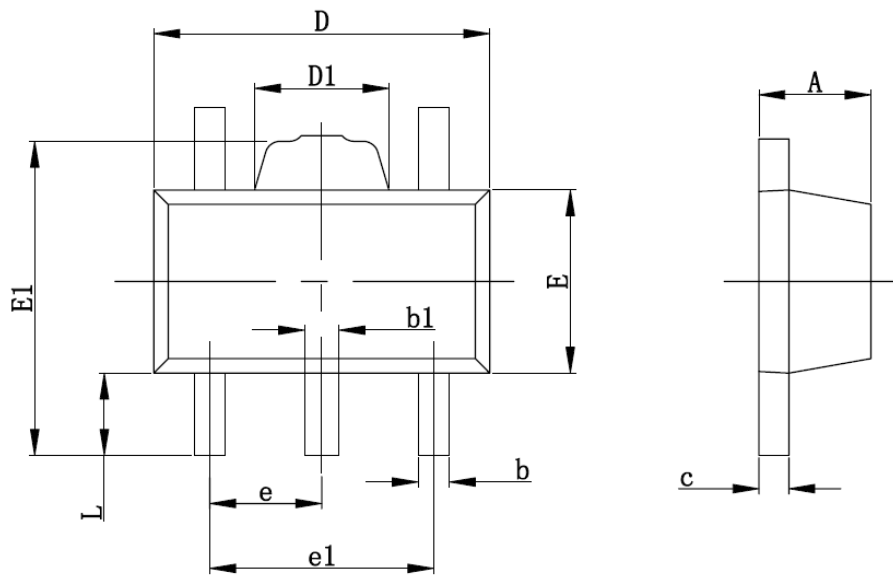

Symbol	Dimensions In Millimeters		Dimensions In Inches	
	Min	Max	Min	Max
A	1.400	1.600	0.055	0.063
b	0.320	0.520	0.013	0.020
b1	0.360	0.560	0.014	0.022
c	0.350	0.440	0.014	0.017
D	4.400	4.600	0.173	0.181
D1	1.400	1.800	0.055	0.071
E	2.300	2.600	0.091	0.102
E1	3.940	4.250	0.155	0.167
e	1.500TYP		0.060TYP	
e1	2.900	3.100	0.114	0.122
L	0.900	1.100	0.035	0.043

© Nanjing Chipower Electronics Inc.

Chipower cannot assume responsibility for use of any circuitry other than circuitry entirely embodied in a Chipower product. No circuit patent license, copyrights or other intellectual property rights are implied. Chipower reserves the right to make changes to their products or specifications without notice. Customers are advised to obtain the latest version of relevant information to verify, before placing orders, that information being relied on is current and complete.